

# AQUAFALL 300 / 600 / 900 1200 / 1500

**(D) BEDIENUNGSANLEITUNG**

**(GB) OPERATING INSTRUCTIONS**

**(F) MODE D'EMPLOI**

**(I) ISTRUZIONI PER L'USO**

**(ES) INSTRUCCIONES PARA EL USO**

**(NL) GEBRUIKSAANWIJZING**

**(PL) INSTRUKCJA OBSŁUGI**

**(PYS) ИНСТРУКЦИЯ ПО МОНТАЖУ  
И ЭКСПЛУАТАЦИИ**

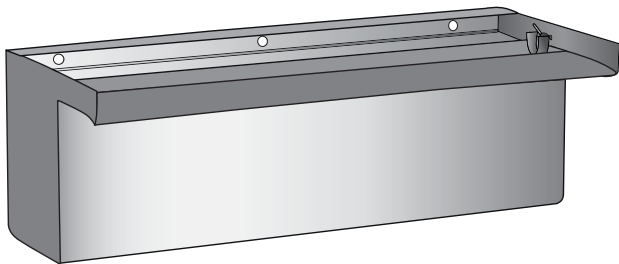

Art-Nr. 46200 Art-Nr. 46230  
Art-Nr. 46210 Art-Nr. 46240  
Art-Nr. 46220

**seliger**<sup>®</sup>  
WATERPOWER

AQUAFALL 300 / 600 - 46200 / 46210 .....	4
AQUAFALL 900 - 46220 .....	8
AQUAFALL 1200 - 46230 .....	13
AQUAFALL 1500 - 46240 .....	18

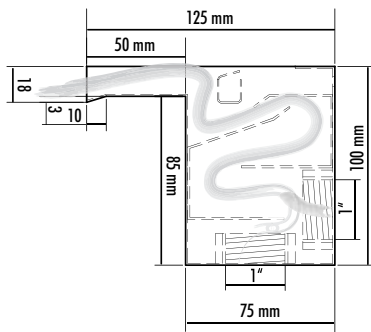
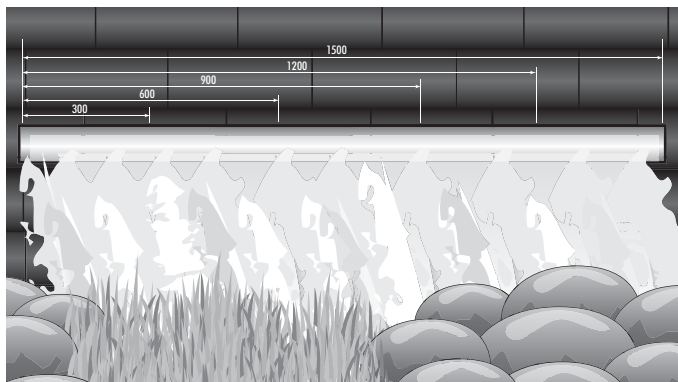

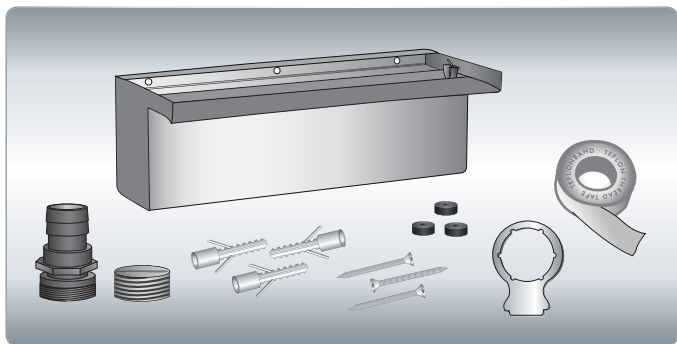
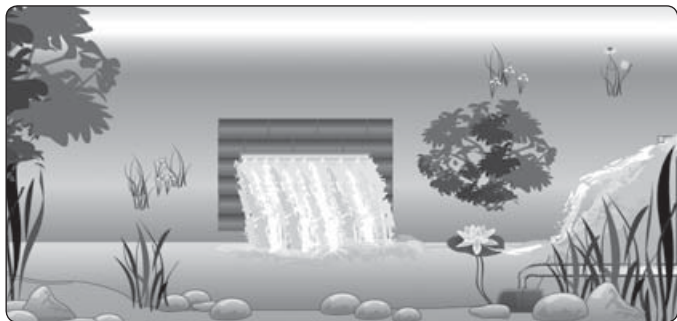

**A**



**1**



**2**

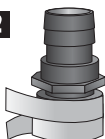

**3**



**4**

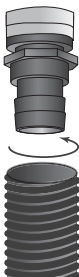

**5**

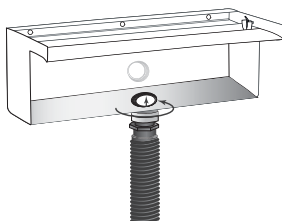
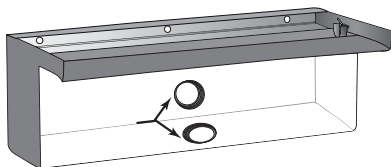

**B**



**1**



**2**



**3**



**4**

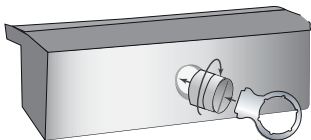

**C**



**1**

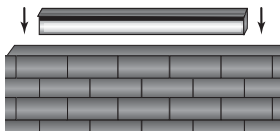

**2**



**3**



**4**

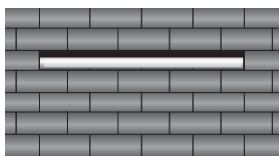

**5**

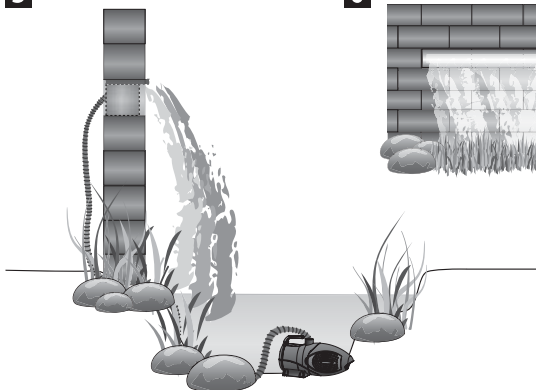

**6**

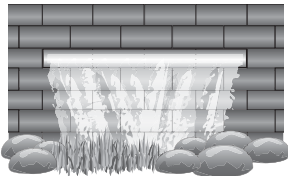

**D**



**1**

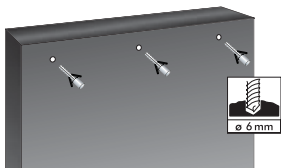

**2**

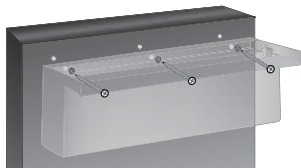

**3**

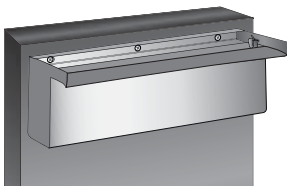

**4**

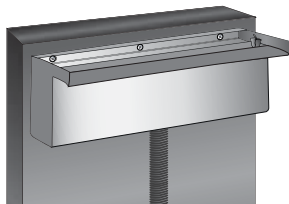

**5**



**6**



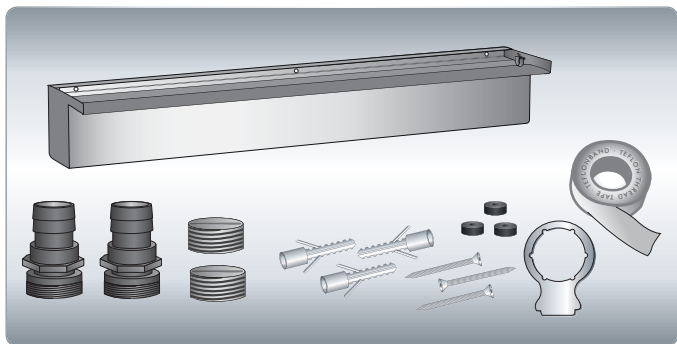
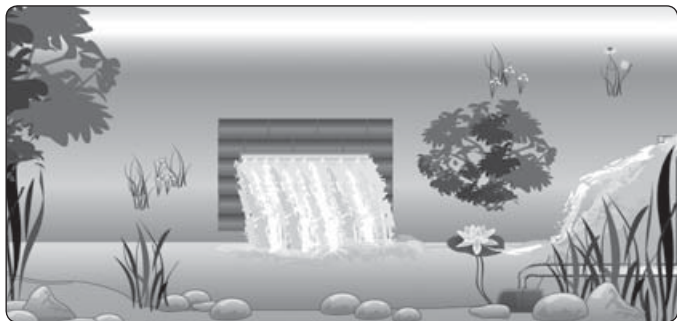

**A**



**1**



**2**

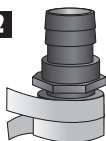

**3**



**4**

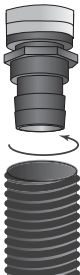

**5**

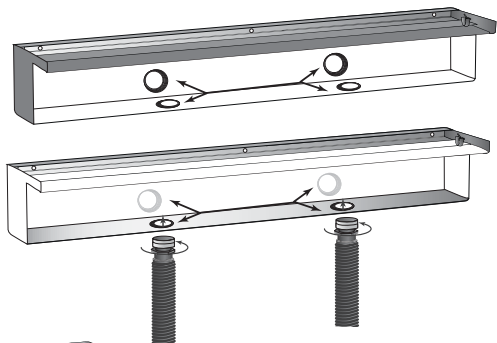

**B**



**1**



**2**



**3**



**4**

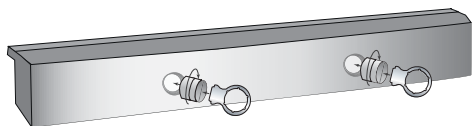



**C**



**1**



**2**



**3**



**4**

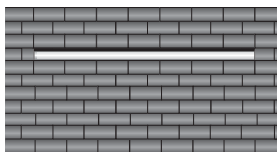

**5**

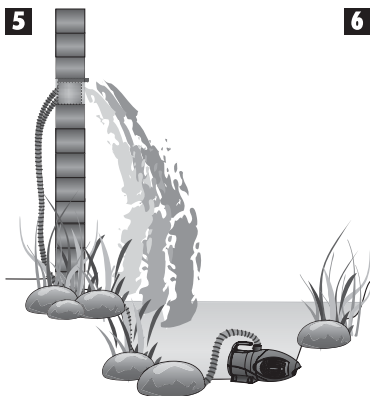

**6**

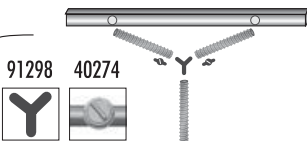
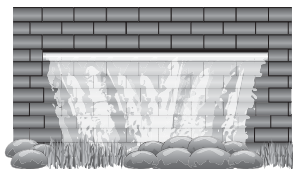

**D**



**1**



**2**



**3**



**10**

4

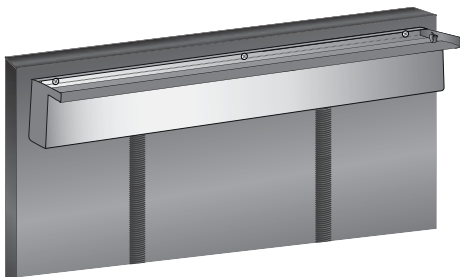

5

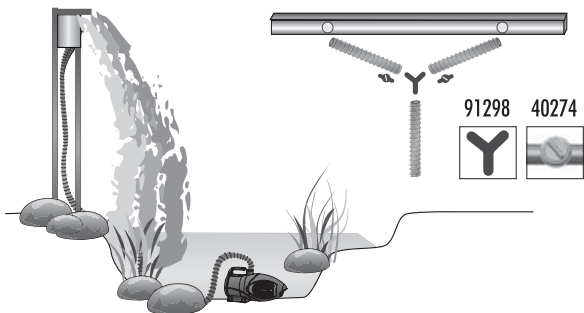

6

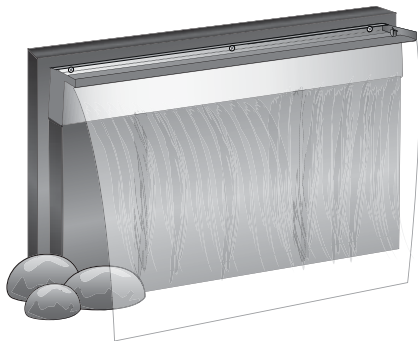

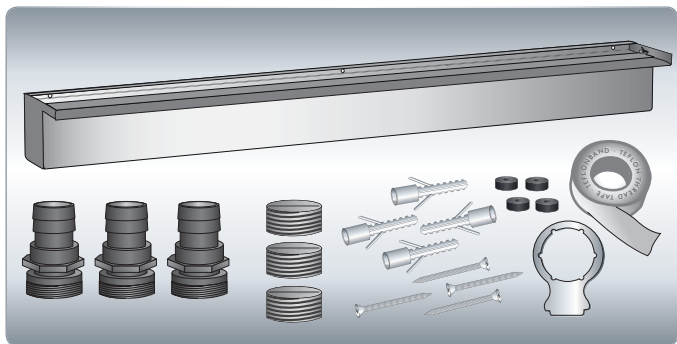
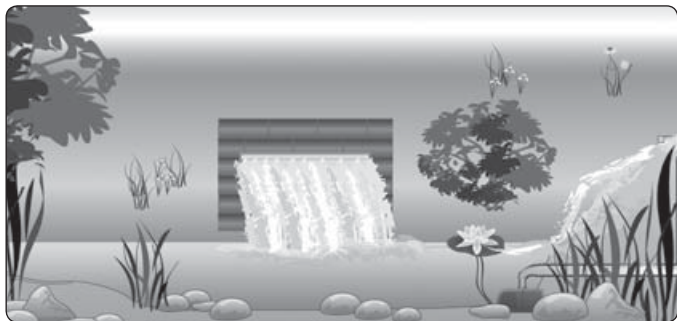

**A**



**1**



**2**

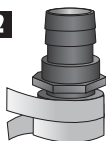

**3**



**4**

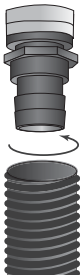

**5**

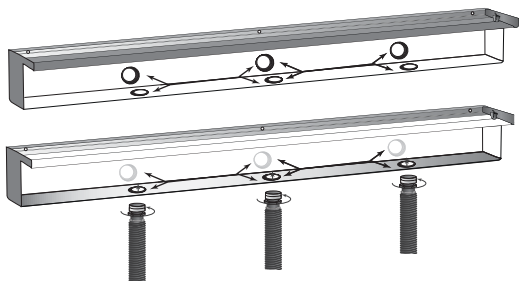

**B**



**1**



**2**



**3**



**4**

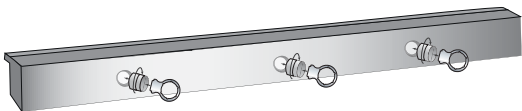

**C**



**1**



**2**

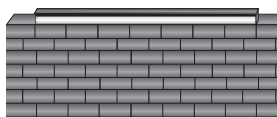

**3**



**4**

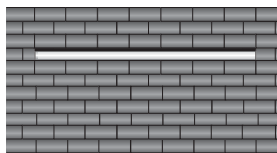

**5**

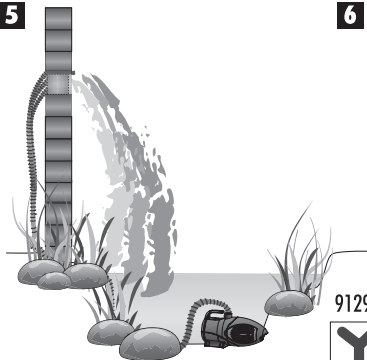

**6**

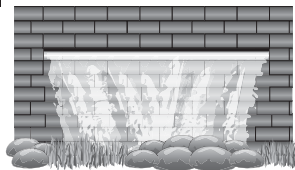

91298

40274

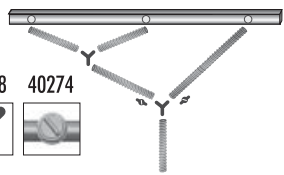

**D**



**1**

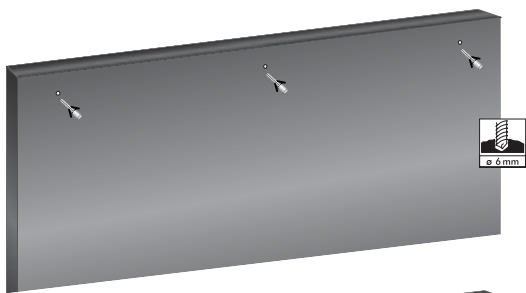

**2**



**3**



4

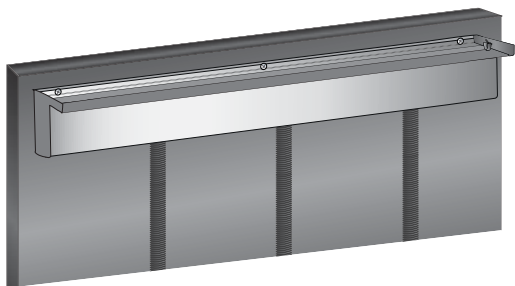

5

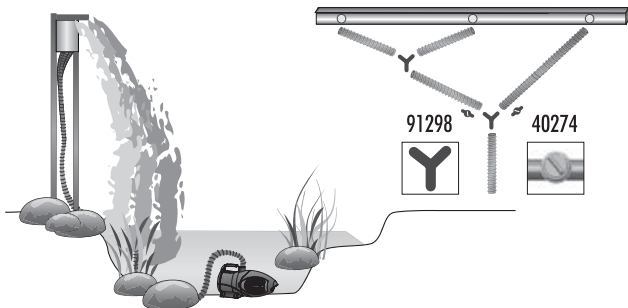

6

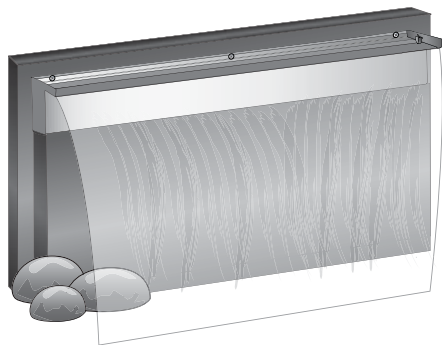



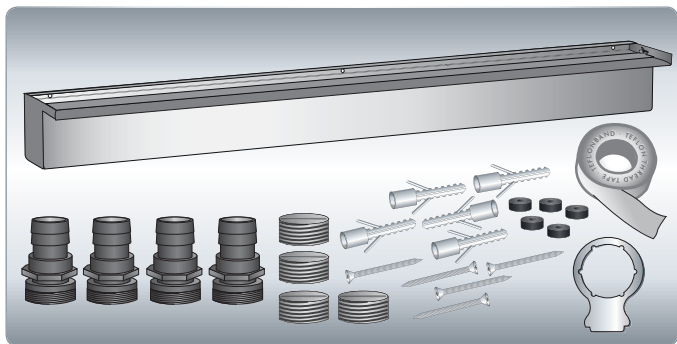
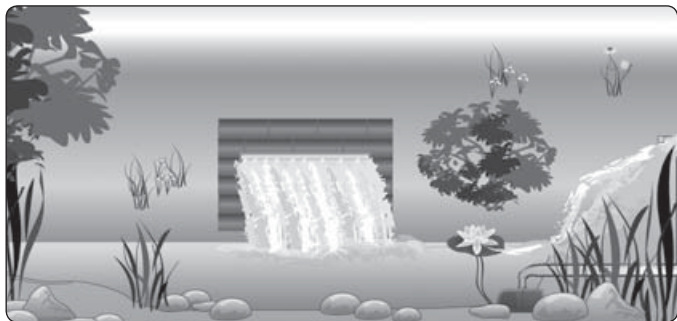

**A**



**1**



**2**

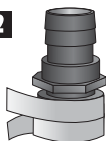

**3**



**4**

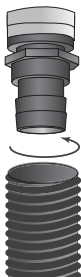

**5**

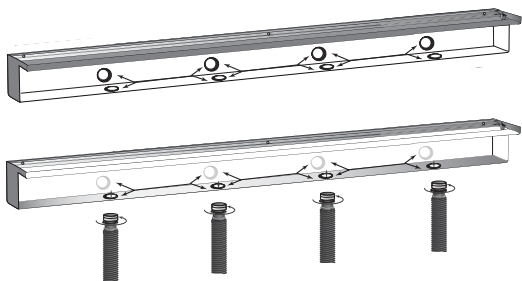

**B**



**1**



**2**



**3**



**4**

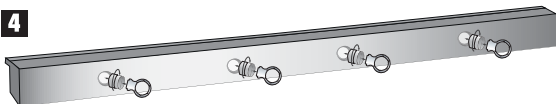

**C**



**1**



**2**

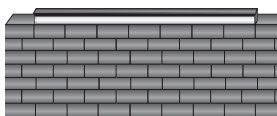

**3**



**4**

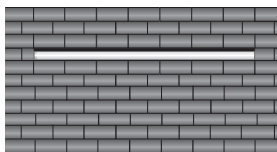

**5**

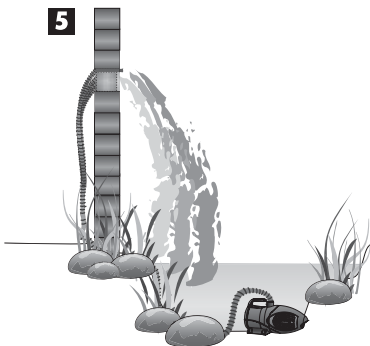

**6**

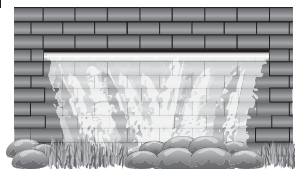

91298



40274

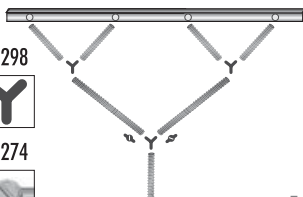

**D**



**1**

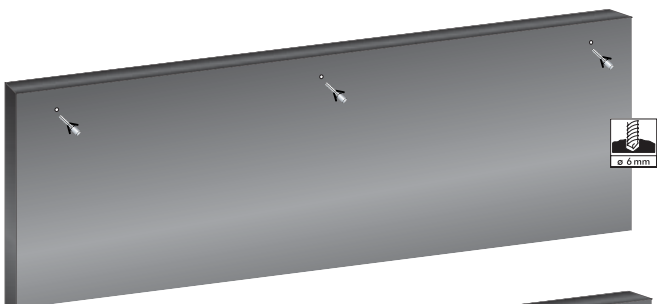

**2**

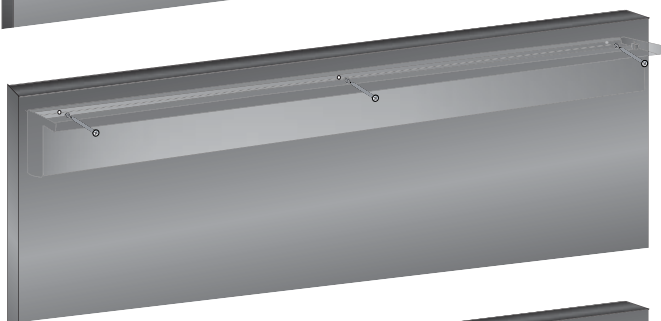

**3**

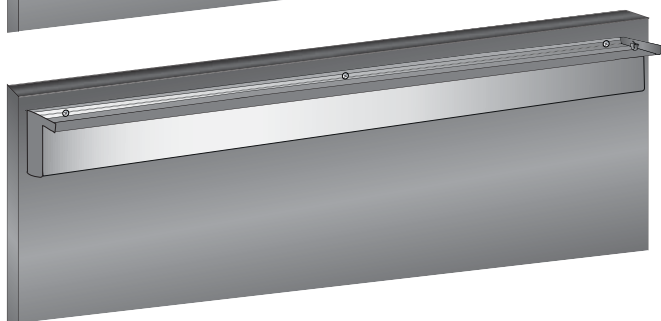

**20**

4

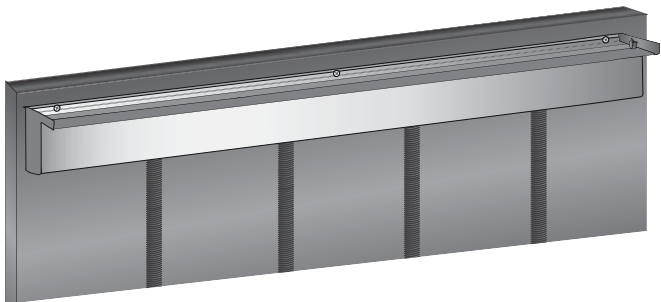

5

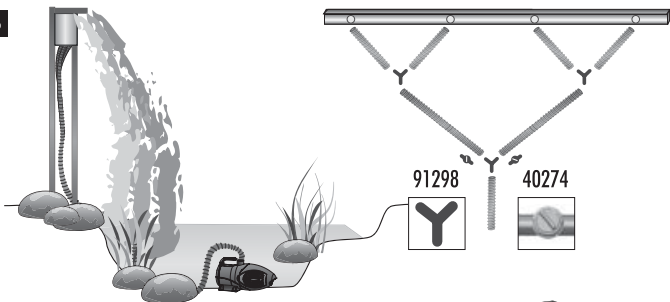

6

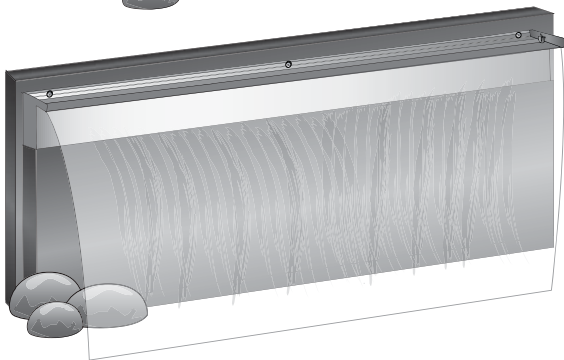



**GARANTIEKARTE · WARRANTY CARD · CARTE DE GARANTIE · CERTIFICATO DI GARANZIA**

---

**Garantie 24 Monate ab Verkaufsdatum** (Nur mit gültigem Verkaufsbeleg)

**Warranty 24 months after the date of purchase** (only valid on presentation of the invoice)

**Garantie 24 mois à compter de la date d'achat** (valable seulement sur présentation du bon d'achat)

**Garanzia 24 mesi a partire dalla data di acquisto** (valido solo con ricevuta di acquisto)

---

Name · Name · Nom · Nome

---

---

---

Adresse · Address · Adresse · Indirizzo

---

---

Telefon · Telephon · Téléphone · Telefono

---

---

---

Fehlerbeschreibung · Fault description · Description des défauts · Difetto

---

---

Kaufdatum · Purchase date · Date d'achat · Data di acquisto

---

---

Händler · Retailer · Revendeur · Negozio specializzato

---

---

Datum · Date · Date · Data

---

---

Unterschrift · Signature · Signature · Firma

---

Garantía 24 meses a contar de la fecha de compra (sólo válida con recibo de compra)

Garantietermijn: 24 maanden na de aankoopdatum (alleen geldig na overleg van de aankoopnota, bewaar deze dus goed)

24 miesiące od daty zakupu (tylko z ważnym dowodem zakupu)

Гарантийный ремонт проводится в течение 24 месяцев со дня продажи

Nombre · Naam · Nazwisko · Имя

Dirección · Adres · Adres · Адрес

Teléfono · Telefoon · Telefon · Телефон

Defecto · Reden van de klacht · Opis usterki · Причина обращения

Fecha de compra · Aankoopdatum · Data zakupu · Дата приобретения

Tienda · Leverancier/dealer · Sprzedawca · Дилер

Fecha · Datum · Data · Дата

Firma · Handtekening · Podpis · Подпись